

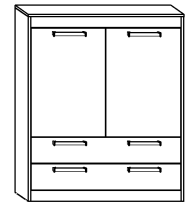

MXS-26 REGAŁ N2D2S

→ 100+121\36



| | | | | | | | | |
|--------------|----------------------------|--------------|---------------|--------------|---------------------------|---------------------------|---------------|--------------|
| x 7 a | x 18 b | x 3 c | x 21 d | x 8 e | x 4 f | | | |
| x 4 g | x 4 h | x 5 i | x 3 j | x 4 k | x 38 (3,5x16) l | x 10 (3,5x30) m | x 70 n | x 1 o |
| x 6 p | x 2 kpl. (300 mm) r | | | | | 60 min | | |

1 - FAZY MONTAŻU

A - OZNACZENIE ELEMENTÓW

a - OZNACZENIE AKCESORIÓW

1

| | | |
|--------------|--------------|--------------|
| x 2 a | x 4 b | x 3 c |
|--------------|--------------|--------------|

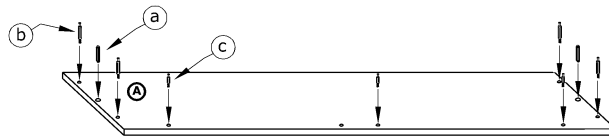

2

| | | |
|---------------------------|-------------------|--------------|
| x 4 a | x 12 b | x 4 f |
| x 4 h | x 4 i | x 2 j |
| x 16 (3,5x16) l | x 2 kpl. r | |

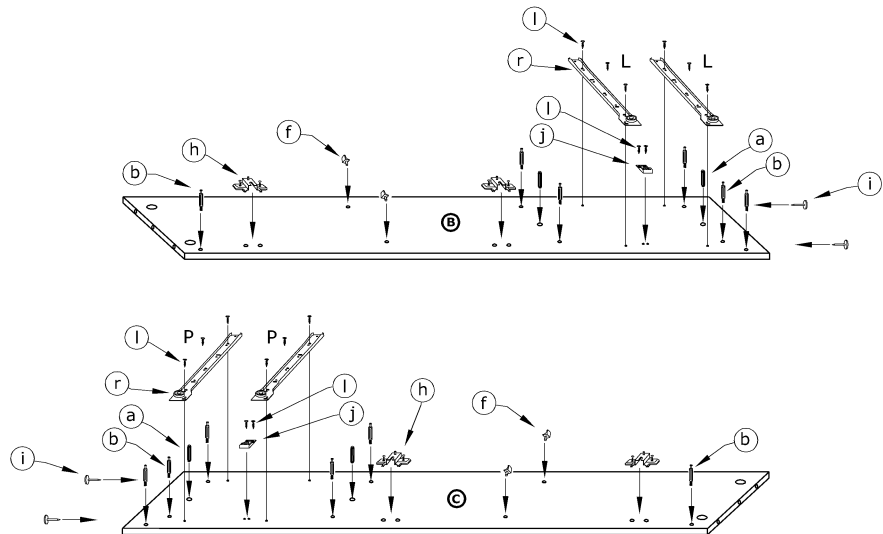

3

| | | | | |
|--------------|--------------|--------------|--------------|--------------------------|
| x 1 a | x 2 b | x 2 d | x 1 j | x 2 (3,5x16) l |
|--------------|--------------|--------------|--------------|--------------------------|

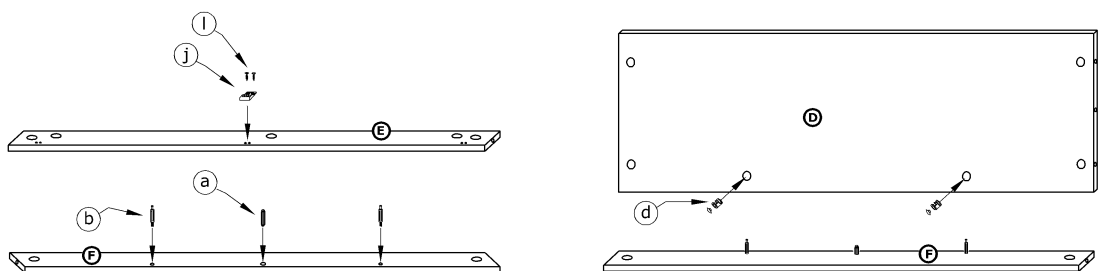

4

x 12



d

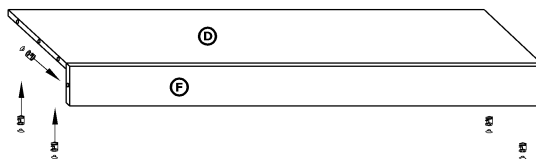
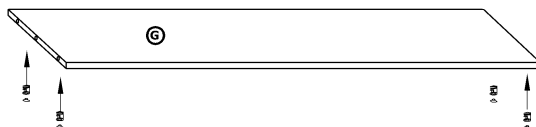
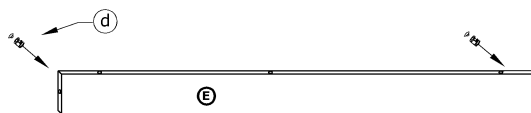
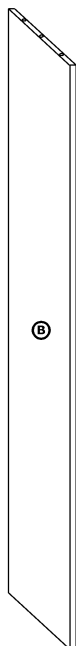

5

x 7

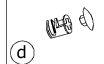

d

x 1



i

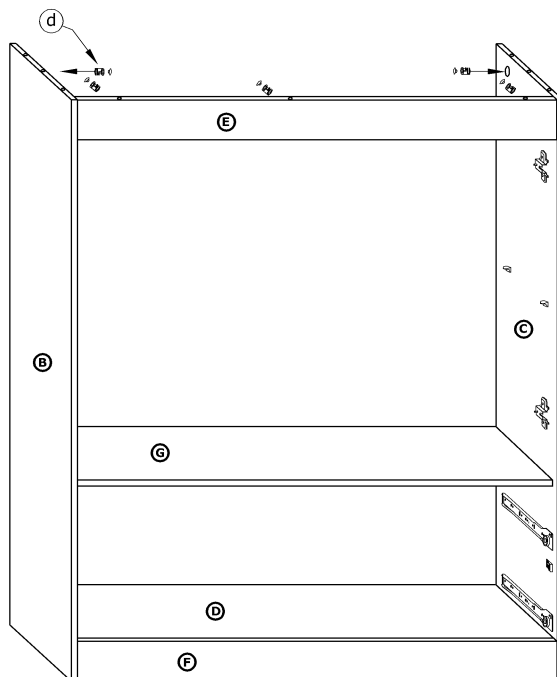
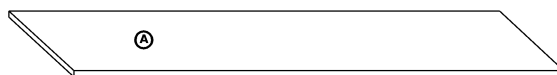

6

x 40

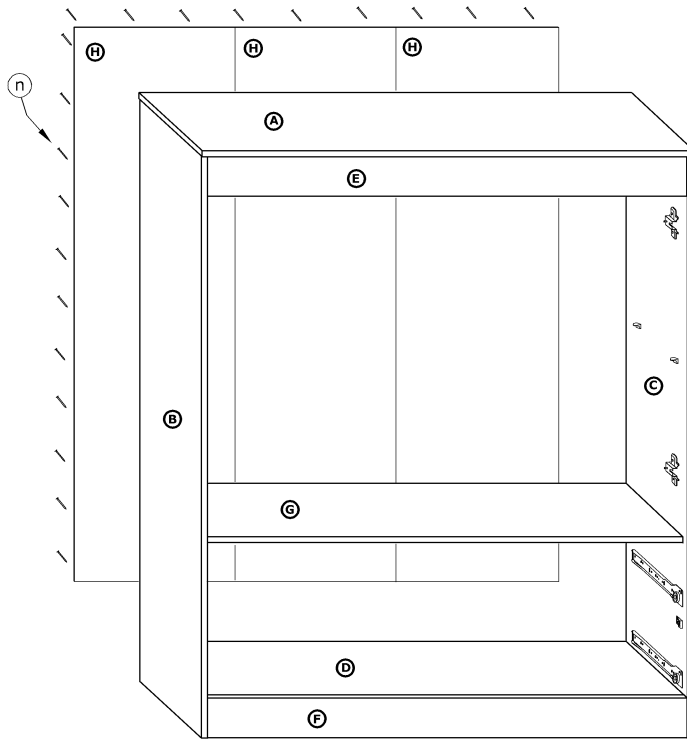
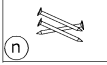
**7**

x 8

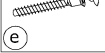

x 4

x 12
(3,5x16)x 4
(3,5x30)

x 30

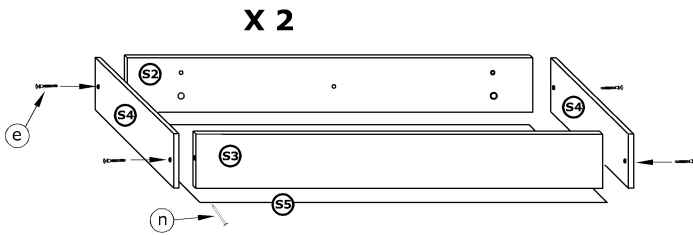
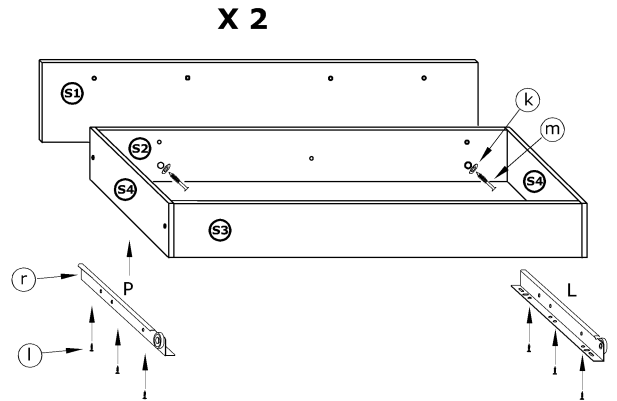

x 2 kpl.

**X 2****X 2****8**

x 4

x 8
(3,5x16)x 6
(3,5x30)

x 6

